

THANK YOU FOR PURCHASING OUR STUDIO DESIGNS:  
GRACIAS POR COMPRAR NUESTRO STUDIO DESIGNS:  
MERCİ D'AVOIR ACHETÉ NOTRE STUDIO DESIGNS:

# Deluxe Presentation Easel

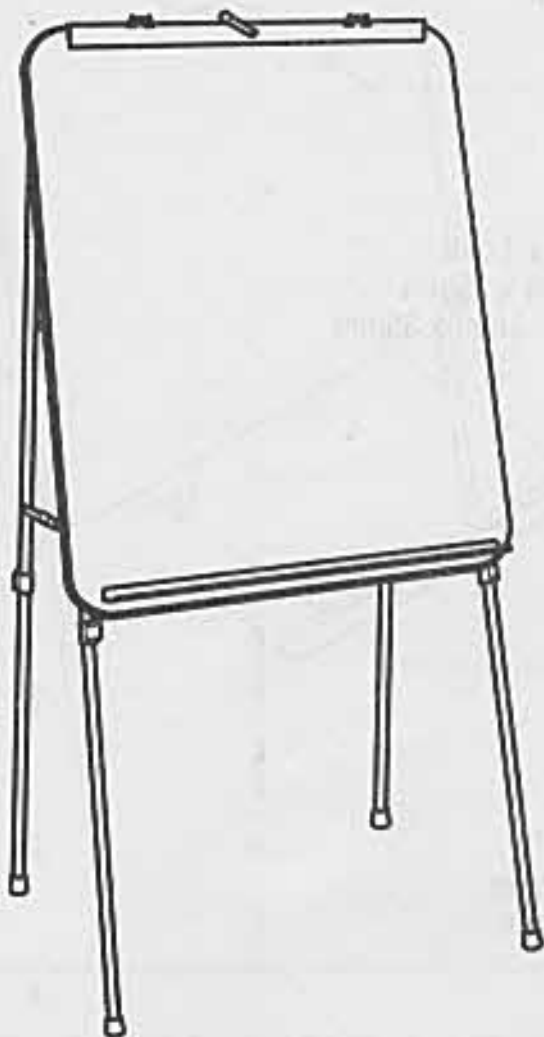

13185 Black • Negro • Noir









studio  designs

INSPIRING CREATIVITY

7255 Rosemead Blvd • Pico Rivera, CA 90660  
Product Support: 1-800-445-1527 (7:00 - 5:00 PST)  
Tel: 562-942-0492 • Fax: 562-942-0531

Rev.03.20.2008

## Parts List • Lista de Partes • Liste des Pièces

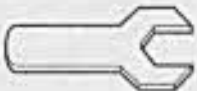
- |    |   |   |   |
|----|---|---|---|
| 1. | Easel<br>Caballete<br>Chevalet  | 1 |    |
| 2. | Upper Clamp<br>Abrazadera Superior<br>Agrafe Supérieure                                       | 1 |    |
| 3. | Lower Clamp<br>Abrazadera Inferior<br>Agrafe Inférieure                                       | 1 |    |
| 4. | Phillips Bolt - 3/16" x 1-3/8<br>Perno de Cruz - 5mm x 35mm<br>Boulon Cruciforme - 5mm x 35mm | 2 |    |
| 5. | Spacer<br>Espaciador<br>Entretoise  | 2 |   |
| 6. | Washer<br>Arandela<br>Rondelle  | 2 |  |
| 7. | Nut<br>Tuerca<br>Écrou  | 2 |  |
| 8. | Phillips Screw - 1/2"<br>Tornillo de Cruz - 12mm<br>Vis Cruciforme - 12mm                     | 2 |  |
| 9. | Hex Wrench<br>Llave Allen<br>Clé Allen  | 1 |  |

**Tools Needed: #2 Phillips Screwdriver**

**Herramientas Requeridas: Destornillador de Cruz #2**

**Outils Requis: Tournevis Cruciforme #2**



Deluxe Presentation Easel

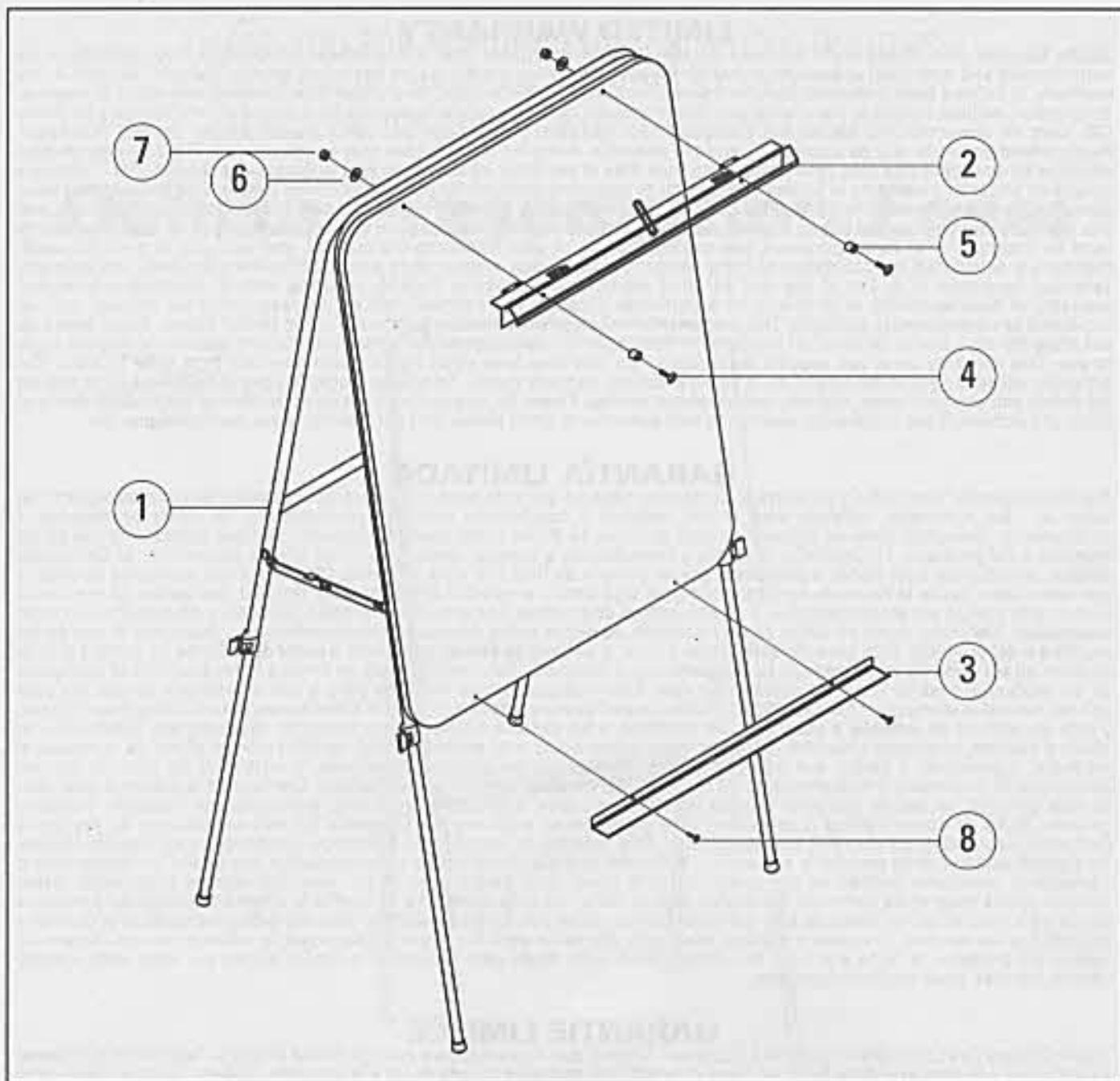

1. Open Easel (1).
2. Attach Upper Clamp (2) using Phillips Bolts (4), Spacers (5), Washers (6) and Nuts (7).
3. Attach Lower Clamp (3) using Phillips Screws (8).

1. Abra el Caballete (1).
2. Fije Abrazadera Superior (2) usando Pernos de Cruz (4), Espaciadores (5), Arandelas (6) y las Tuercas (7).
3. Fije la Abrazadera Inferior (3) usando los Tornillos de Cruz (8).

1. Ouvrez le Chevalet (1).
2. Attachez l'Agrafe Supérieure (2) à l'aide des Boulons Cruciformes (4), Entretoises (5), Rondelles (6) et des Écrous (7).
3. Attachez l'Agrafe Inférieure (3) à l'aide des Vis Cruciformes (8).